

Instructions and installation manual

MODELS:

BSGH95-ANZ / BSGH75-ANZ

BSGH64-ANZ / BSGH32-ANZ

BSGH30-ANZ

**PLEASE READ THIS MANUAL BEFORE
INSTALLING THE COOKTOP.**

DESIGN
STUDIO SOLARI

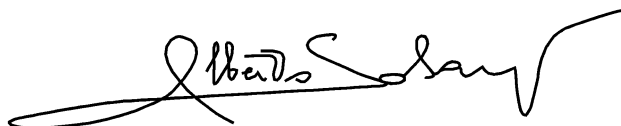

Baumatic

DESCRIPTION OF COOKTOP

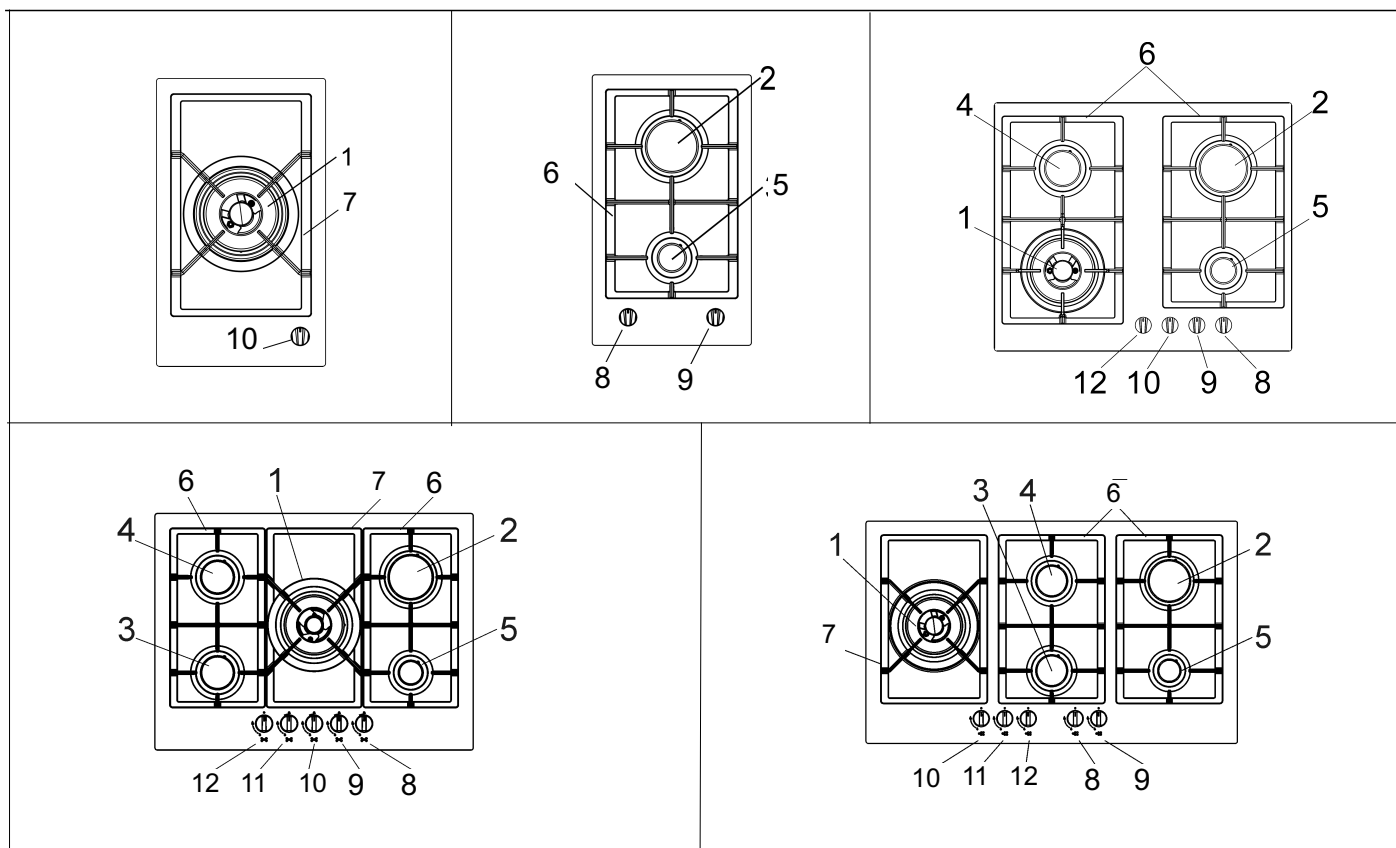

- 1 Ultra rapid gas burner/WOK
- 2 Rapid gas burner
- 3 Semirapid reduced gas burner
- 4 Semirapid gas burner
- 5 Auxiliary gas burner
- 6 Pan stands support 2F
- 7 Pan stands support 1F
- 8 Burner n° 2 control knob
- 9 Burner n° 5 control knob
- 10 Burner n° 1 control knob
- 11 Burner n° 3 control knob
- 12 Burner n° 4 control knob

Natural	U-LPG
14.5 MJ/h	12.6 MJ/h
12.0 MJ/h	10.4 MJ/h
5.4 MJ/h	4.9 MJ/h
7.1 MJ/h	6.3 MJ/h
4.1 MJ/h	3.6 MJ/h

**To use the WOK pan support on ultra rapid gas burner only.
Put it on the ultra rapid pan support and make sure of the stability (see fig. A).**

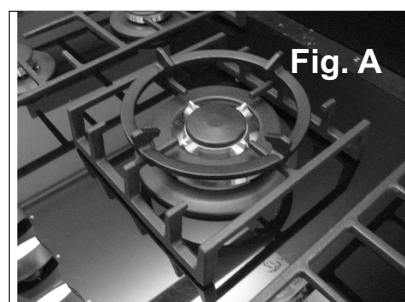

Attention: this appliance has been manufactured for domestic use only. Do not modify this appliance.

USE

1) BURNERS

A diagram is screen-printed above each knob on the front panel. This diagram indicates to which burner the knob in question corresponds. After having opened the gas mains or gas bottle tap, light the burners as described below:

- automatic electrical ignition

Push and turn the knob corresponding to the required burner in an anticlockwise direction until it reaches the full on position (large flame fig. 1), then depress the knob.

- Lighting burners equipped with flame failure device

The knobs of burners equipped with flame failure device must be turned in an anticlockwise direction until they reach the full on position (large flame fig. 1) and come to a stop. Now depress the knob in question and repeat the previously indicated operations.

Keep the knob depressed for about 10 seconds once the burner has ignited.

Note: you are advised not to try and light a burner if the flame divider (burner Cap) is not correctly placed

In the event of the Burner flames being accidentally extinguished, turn off the burner control and do not attempt to re-ignite the burner for a least 1 minute.

HOW TO USE THE BURNERS

Bear in mind the following indications in order to achieve maximum efficiency with the least possible gas consumption:

- Use adequate pans for each burner (consult the following table and fig. 2).
- When the pan comes to the boil, set the knob to the reduced rate position (small flame fig. 1).
- Always place a lid on the pans.
- Use only pan with a flat bottom.

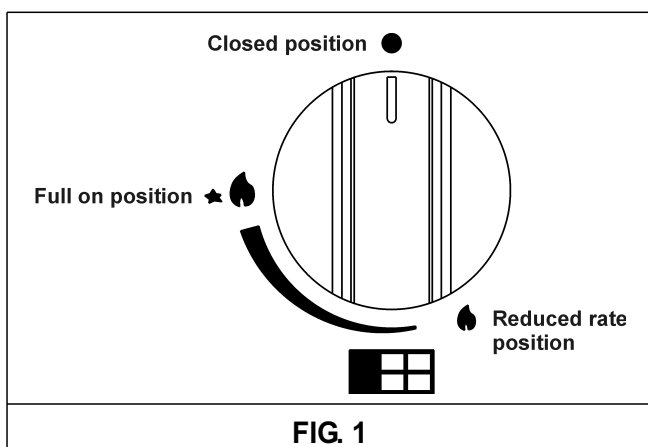

Burners	Power ratings		Pan Ø in cm
	Natural	U-LPG	
Ultra rapid/WOK	14.5 MJ/h	12.6 MJ/h	24 ÷ 26
Rapid	12.0 MJ/h	10.4 MJ/h	20 ÷ 22
Semirapid reduced	5.4 MJ/h	4.9 MJ/h	16 ÷ 18
Semirapid	7.1 MJ/h	6.3 MJ/h	16 ÷ 18
Auxiliary	4.1 MJ/h	3.6 MJ/h	10 ÷ 14

WARNINGS:

- **Burners with flame failure device may only be ignited when the relative knob has been set to the Full on position (large flame fig. 1).**
- **Matches can be used to ignite the burners in a blackout situation.**
- **Never leave the appliance unattended when the burners are being used. Make sure there are no children in the near vicinity. Particularly make sure that the pan handles are correctly positioned and keep a check on foods requiring oil and grease to cook since these products can easily catch fire.**
- **The appliance must not be used by people (including children) with impaired mental or physical capacities, or without experience of using electrical devices, unless supervised or instructed by an expert adult responsible for their care and safety. Children should not be allowed to play with the equipment.**
- **Never use aerosols in the vicinity of this appliance while it is in operation.**
- **Should a crack appear on the surface of the glass, disconnect the appliance from the electricity supply immediately.**
- **Do not place pans with an unstable or deformed bottom on the burner, as these may tip or spill their contents, causing accidents.**
- **Do not store or use flammable liquids or items in the vicinity of the cooktop.**
- **Do not use the hob as a work surface.**
- **This product is not to be installed in marine crafts, caravans, or mobile homes.**
- **Containers wider than the unit are not recommended.**
- **Avoid scraping the pans on the glass surface, as the surface may become scratched.**
- **Do not modify this appliance.**

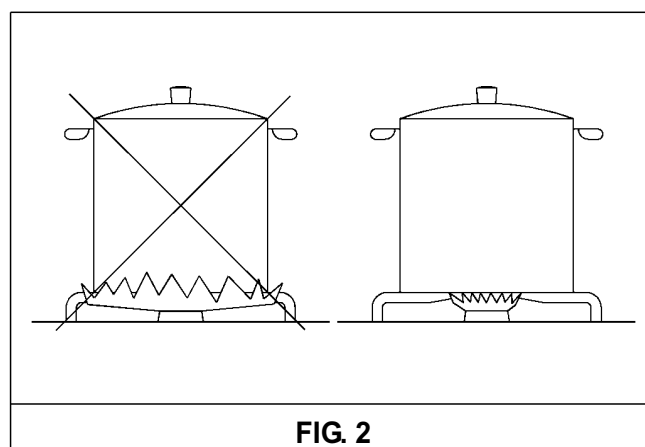

USE

WARNINGS AND ADVICE FOR THE USER:

- Do not attempt to change the technical characteristics of the product because it can be dangerous.
- If you decide longer use this appliance any more (or replace an old model), before disposing of it, make it inoperative in conformity with current law on the protection of health and the prevention of environmental pollution by making its dangerous parts harmless, especially for children who might play on an abandoned appliance.
- Do not touch the appliance with wet or damp hands or feet.
- Do not use the appliance barefoot.
- The manufacturer will not be liable for any damage resulting from improper, incorrect or unreasonable use.
- During, and immediately after operation, some parts of the cooktop are very hot: avoid touching them.
- After using the cook top, make sure that the knob is in the closed position and close the main tap of the gas supply or gas cylinder.
- If the gas taps are not operating correctly, call the Customer Care Department.

Abnormal operations:

Any of the following are considered to be abnormal operation and may require servicing:

- Yellow tipping of the hob burner flame.
- Sooting up of cooking utensils.
- Burners not igniting properly.
- Burners failing to remain alight.
- Burner extinguished by cupboard doors.
- Gas valves which are difficult to turn.

Symbol 1



Do not place anything, eg. flame tamer, asbestos mat, between pan and pan support as serious damage to the appliance may result.

Symbol 2



Do not remove the pan support and enclose the burner with a wok stand as this will concentrate and deflect heat onto the cooktop.

Symbol 3



Do not use large pots or heavy weights which can bend the pan support or deflect flame onto the cooktop.

Symbol 4



Locate pan centrally over the burner so that it is stable and does not overhang the appliance.

Symbol 5



Use only a wok support supplied or recommended by the manufacturer of the appliance.

CLEANING

IMPORTANT:

Always disconnect the appliance from the gas and electricity mains before carrying out any cleaning operation.

2) COOKTOP

Periodically wash the cooktop, the pan stand support, the enamelled burner caps "C" and the burner heads "M" (see fig. 3) with lukewarm soapy water. Following this, all parts should be thoroughly rinsed and dried. Never wash them while they are still warm and never use abrasive powders.

Do not allow vinegar, coffee, milk, salted water, lemon or tomato juice from remaining in contact with the surfaces for long periods of time.

WARNINGS:

Comply with the following instructions, before remounting the parts:

- Check that burner head slots "M" (fig. 3) have not become clogged by foreign bodies.
- Check that the enamelled burner cap "C" (fig. 3) has been correctly positioned on the burner head. It must be steady.
- Do not force the taps if they are difficult to open or close. Contact an Authorised Service Centre for repairs.
- Don't use steam jets for cleaning the cooktop.

1f - 2f (30 Cm) Vetroceramic

If you wish to maintain the shine of the ceramic surface, treat the glass with a silicon-based film product before use to protect the surface against water and dirt. This protective film is not durable, so it is advisable to repeat the application of the product frequently.

It is very important to clean the hob every time you use it, while the glass is still warm.

Do not clean using abrasive metal scourers, powder abrasives or corrosive sprays.

Depending on the degree of dirt, we recommend:

- for light stains, a damp sponge is sufficient.
- Tough, encrusted dirt is easily eliminated using a scraper (fig. 3/A), not supplied with the hob, but easy to find in local stores. **Use the scraper carefully to avoid damaging the hob.**
- Traces of liquid spilled from pans can be eliminated with vinegar or lemon juice.
- **Never allow sugar or sugary foods to fall on the hob while cooking. Should this occur, switch off the hob and clean it immediately with hot water, using a scraper on hot spills.**
- As time goes by metallic reflections, colouring or scratches may appear due to poor cleaning and the incorrect movement of pans. Scratches are hard to eliminate but do not affect the correct operation of your hob.
- Do not use jets of steam to clean the appliance.

Note: continuous use could cause the burners to change colour due to the high temperature.



FIG. 3



FIG. 3/A

INSTALLATION

TECHNICAL INFORMATION FOR THE INSTALLER

This appliance shall be installed only by authorised personnel and in accordance with the manufacturer's installation instructions, local gas fitting regulations, municipal codes, electrical wiring regulations, NZS5261:2003, AS 5601 - Gas Installation and any other statutory regulations. Ventilation must be in accordance with AS 5601, NZS5261:2003 - Gas installation. In general, the appliance should have adequate ventilation for complete combustion of gas, proper flueing and to maintain temperature of immediate surroundings safe limits.

The wall and bench surfaces must be capable of sustaining temperatures of 75 °C. All laminates, fixing adhesive and surfacing materials should be certified suitable for this temperature.

CAUTION:

the installer shall test the appliance before leaving. Test the safety operation of the ignition system on all burners individually and combined.

3) INSTALLING THE COOKTOP

Check that the appliance is in a good condition after having removed the outer packaging and internal wrappings from around the various loose parts. In case of doubt, do not use the appliance and contact qualified personnel.

Never leave the packaging materials (cardboard, bags, polystyrene foam, nails, etc.) within children's reach since they could become potential sources of danger.

The measurements of the opening made in the top of the modular cabinet and into which the cooktop will be installed are indicated in either fig. 4. Always comply with the measurements given for the hole into which the appliance will be recessed (see fig. 4).

The appliance belongs to class 3 and is therefore subject to all the provisions established by the provisions governing such appliances.

Any adjoining wall surface situated within 200 mm from the edge of any hob burner must be a suitable non-combustible material for a height of 150 mm for the entire length of the hob. Any combustible construction above the top of the burner and no construction shall be within 450 mm above the top of the burner. A minimum depth of 70 mm from the top of the work surface must be provided for this appliance.

COMPLY WITH THE DIMENSIONS (in mm)

	A	B	C	D	E
1F-2F (30)	282	473	59	59	100 min.
4F (60)	553	473	63.5	63.5	173.5 min.
5F (70)	645	473	63.5	63.5	173.5 min.
5F (90)	833	475	62.5	62.5	73.5 min.

Caution: Do not allow the glass (A) lay directly on the work top. it is the bottomshelf (B) that has to be in touch with the work top (see fig. 4/A).

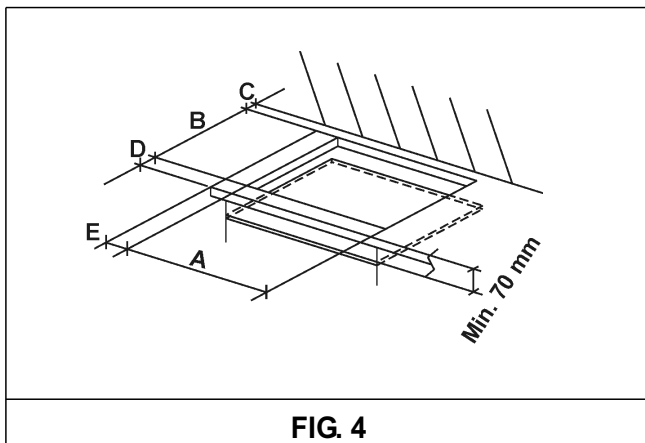

FIG. 4

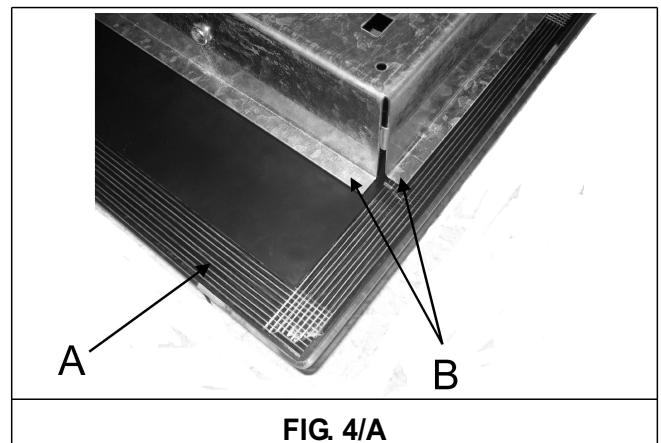

FIG. 4/A

INSTALLATION

4) FIXING THE COOKTOP

The cooktop has a special seal which prevents liquid from getting into the cabinet. Strictly comply with the following instructions in order to correctly apply this seal:

- Take off all the movable parts of the hob.
- Cut the seal in 4 parts of the necessary length to positioning it on the 4 edges of the glass.
- Overturn the cooktop and correctly position seal "E" (fig. 5) under the edge of the cooktop itself, so that the outer side of the seal perfectly matches the outer edge of the cooktop. The ends of the strips must fit together without overlapping.
- Evenly and securely fix the seal to the cooktop, pressing into place with the fingers and remove the strip of protective paper from the seal and set the plate into the hole made in the cabinet.
- Position the hob in the hole in the unit and fasten it in place using the appropriate screws "F" and the fastening hooks "G" (fig. 6).

- When the appliance is installed so that the base can be touched, we recommend fitting a protecting shield. **This shield must be at least 70 mm below the base of the bench top (fig. 4).** Timber or other suitable material may be used provided it is capable of withstanding the appliance temperatures. Ensure that the supply connection point is accessible with the appliance installed. To facilitate shield may need to be removable.

NOTE: do not fix the cooktop into the bench with sealant (ie silicon) as this may void the warranty. Use only the seals provided.

IMPORTANT: a perfect installation, adjustment or transformation of the cook top to use other gases requires a QUALIFIED INSTALLER: a failure to follow this rule will void the warranty.

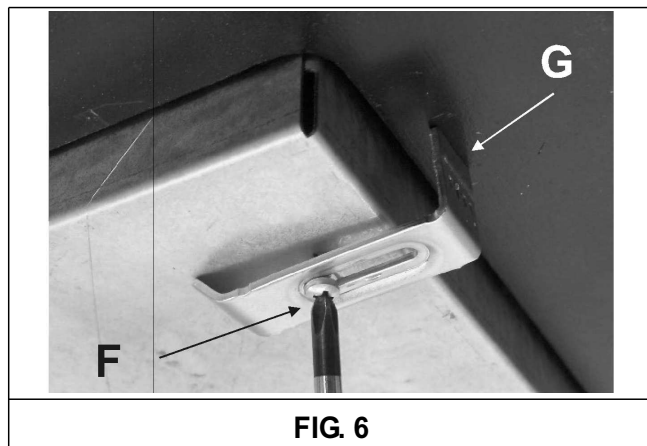
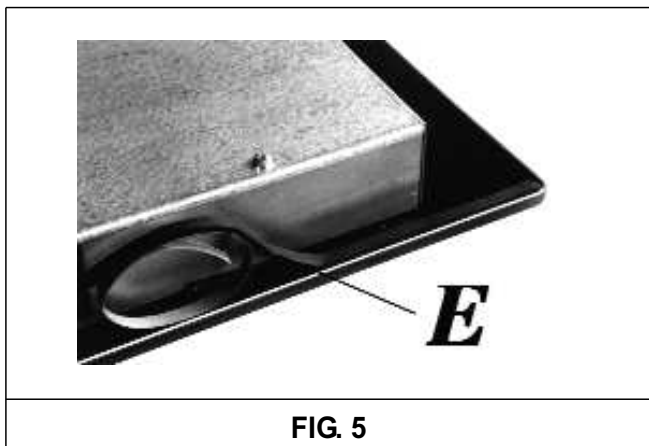

INSTALLATION

5) GAS CONNECTION

The gas connection is located in the rear and on the underside of the appliance 100 mm from the right hand side.

There are two ways to carry out the connection to the main gas line:

A. The cooktop can be connected with rigid pipe as specified in AS5601 table 3.1.

B. If installing with a hose assembly, install with a hose assembly that complies with AS/ANZ 1869 (AGA Approved), 10 mm ID, class B or D, no more than 1.2 m long and in accordance with AS5601. Ensure that the hose does not contact the hot surfaces of the cooktop, oven, dishwasher or any other appliance that may be installed underneath or next to the cooktop. The hose should not be subjected to abrasion, kinking or permanent deformation and should be able to be inspected along its entire length with the cooktop in the installed position.

Unions compatible with the hose fittings must be used and all connections tested for gas leaks.

The gas supply connection for the hose assembly must be accessible.

Warning: ensure that the hose assembly is restrained from accidental contact with the flue or flue outlet of an underbench oven.

Natural Gas

Natural Gas installations require the connection of a gas regulator at the appliance. This regulator is supplied with the appliance on purchase.

Assemble the regulator (noting the gas flow direction) and transition pieces (supplied with the appliance), in accordance with figure 7.

The transition piece on the supply side of the regulator must be provided by the installer.

Liquefied Petroleum Gas.

In a Universal LP Gas installation the gas regulation is made at the gas cylinder and regulation at the appliance is not required. To connect supply to the appliance use transition pieces as shown in figure 8. These pieces are supplied with the appliance on purchase.

WARNING:

THE BURNER FLAME MUST BE ADJUSTED BY THE INSTALLER.

FAULTY INSTALLATION WILL NOT BE COVERED UNDER WARRANTY.

THE APPLIANCE IS FACTORY SET FOR NATURAL GAS. THE TEST POINT PRESSURE SHOULD BE ADJUSTED TO 1.00kPa WITH THE WOK BURNER OPERATING AT MAXIMUM.

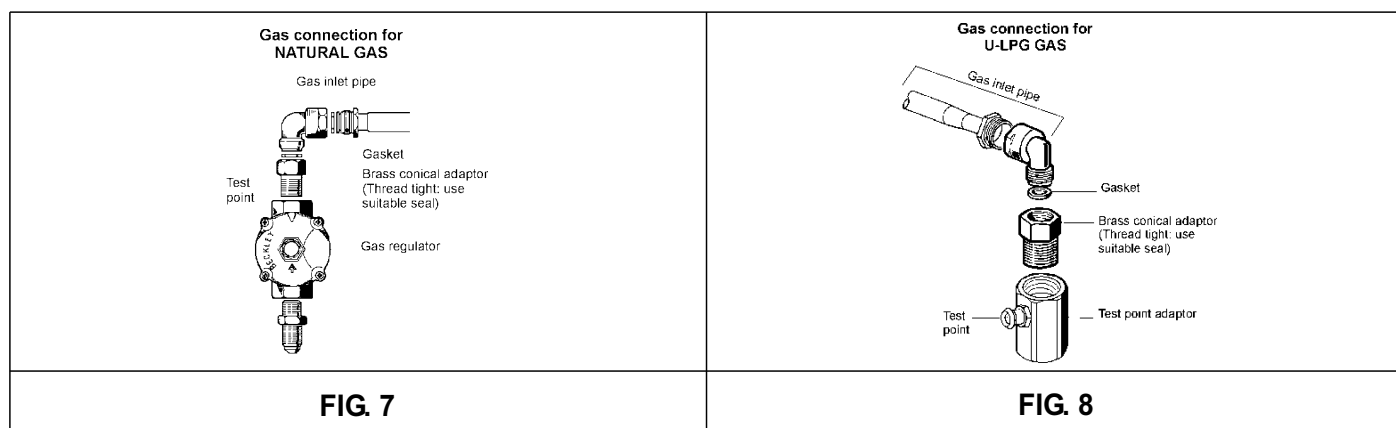

INSTALLATION

6) ELECTRICAL CONNECTION

IMPORTANT: the appliance must be installed following the manufacturer's instructions. The manufacturer will not be liable for injury to persons or animals or property damage caused by an incorrect installation.

The appliance is supplied with a 1800 mm long flexible supply lead.

The point of attachment for this lead is located at the rear and on the underside of the appliance 380 mm from the right hand side.

The voltage and power consumption are detailed on the underside of the appliance. Ensure that the appliance is correctly rated to the supply.

Connect appliance by way of a switched power point.

THE APPLIANCE MUST BE EARTHED

Ensure that this power point is properly earthed. Look at the connection wiring diagrams alongside.

Warning: in order to avoid any hazard, any electrical work performed on this equipment or its associated wiring, should only be done by a qualified person.

The socket outlet for this cooktop shall be installed near the cooktop and shall be easily accessible.

The electrical connections of the appliance must be carried out in compliance with the provisions and standards in force.

Before connecting the appliance, check that:

- The voltage matches the value shown on the specification plate and the section of the wires of the electrical system can support the load, which is also indicated on the specification plate.
- The electrical capacity of the mains supply and current sockets suit the maximum power rating of the appliance (consult the data label applied to the underside of the cooktop).
- The socket or system has an efficient earth connection in compliance with the provisions and standards in force. The manufacturer declines all responsibility for failing to comply with these provisions.

Before performing any service on the electrical part of the appliance, it must absolutely be disconnected from the electrical network.

If the installation requires modifications to the home's electrical system or if the socket is incompatible with the appliance's plug, have changes or replacements performed by professionally-qualified person. In particular, this person must also make sure that the section of the wires of the socket is suitable for the power absorbed by the appliance.

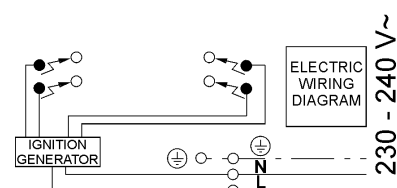
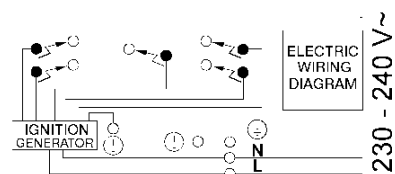
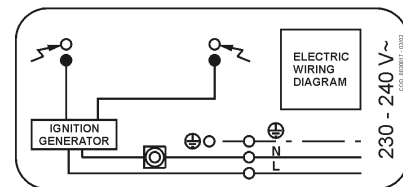
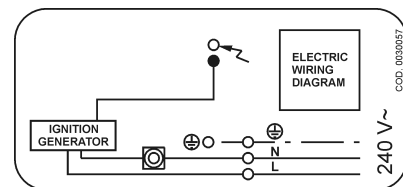

ADJUSTMENTS

Always disconnect the appliance from the electricity main before making any adjustments. All seals must be replaced by the technician at the end of any adjustments or regulations.

Our burners do not require primary air adjustment.

a) Data Label

The Data Label is located on the underside of the cooktop. A duplicate Data Label is supplied to adhere in an accessible area next to the cooktop. This cooktop is suitable for Natural Gas and Universal LP Gas; ensure that the available gas supply matches the Data Label.

b) Before Leaving

Check that there are no gas leaks, but do not use a naked flame to detect gas leaks. Ignite all burners to ensure correct operation of gas valves, burners, ignition and if fitted, flame failure valves. Turn gas taps to low flame position and observe stability of the flame. When satisfied with the cooktop, please instruct the user on the correct method of operation. In case the appliance fails to operate correctly after all checks have been carried out, refer to the authorised service provider in your area.

7) TAPS

Our taps are suitable for all gas, they are male conical type.

“Reduced rate” adjustment

- Switch on the burner and turn the relative knob to the “Reduced rate” position (small flame fig.1- pag. 3).
- Remove knob “M” (fig. 9 and 9/A) of the tap, which is simply pressed on to its rod. The by-pass for minimal rate regulation can be: beside the tap (fig. 9) or inside the shaft. In any case, to access to regulation, it can be done through the insertion of a small screwdriver “D” beside the tap (fig. 9) or in the hole “C” inside the shaft of tap (fig 9/A). Turn the throttle screw to the right or left until the burner flame has been adequately regulated to the “Reduced rate” position.

The flame should not be too low: the lowest small flame should be continuous and steady. Re-assemble the several components.

It is understood that only burners operating with Natural gas should be subjected to the above mentioned adjustments.

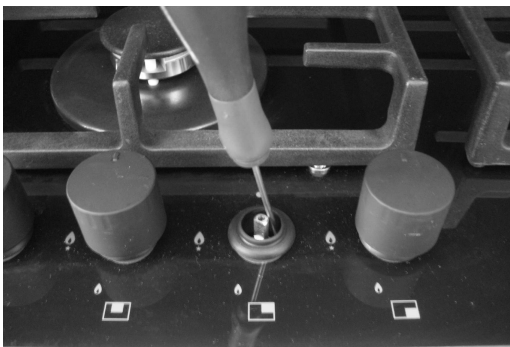

FIG. 9

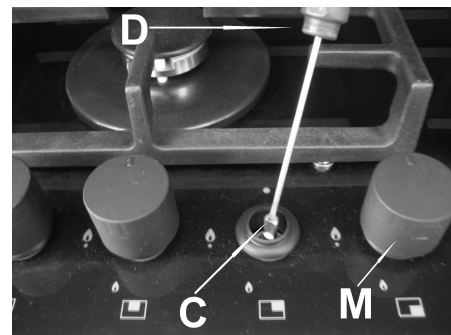

FIG. 9/A

CONVERSIONS

8) UNIVERSAL LP GAS TO NATURAL GAS CONVERSION PROCEDURE

Appliance models: Gas stainless steel cooktop models:

BSGH30-ANZ	1 Burners
BSGH32-ANZ	2 Burners
BSGH64-ANZ	4 Burners
BSGH75-ANZ	5 Burners
BSGH95-ANZ	5 Burners

1. Remove each burner cap and burner skirt.
2. Remove the Universal LP Gas main injector with a 7 mm/VF tube spanner and replace with the appropriate size Natural Gas injector for each burner. The following injector sizes are required for Natural Gas:

Burner	Main injector
Wok	1.75 B mm
Rapid	1.55 mm
Semi Rapid Reduced	1.05 mm
Semi Rapid	1.20 mm
Auxiliary	0.90 mm

3. Shut off gas supply to the appliance.
4. Disconnect gas inlet pipe from the Universal LP Gas test point inlet fitting.
5. Remove the Universal LP Gas test point inlet fitting from the appliance.
6. Fit the Natural Gas Regulator supplied in the conversion kit.
7. Connect the gas supply to the Regulator.
8. Check for gas leaks. Do not use a naked flame to check for gas leaks.
9. Adjust the gas pressure to 1.00 kPa.
10. Remove the control knob, with a thin shaft blade screwdriver down the centre of each gas valve shaft, screw the by-pass injector anti-clockwise. Test the appliance on both high and low flame for each burner. If the burner fails to remain alight or the flame is not stable on the simmer setting, adjust the by-pass screw, until flame is stable.
11. If not already removed, remove the "Only for use with Universal LP Gas" label adhered to the bottom panel near the gas connection.
12. Fit the new data label included in the gas conversion kit.

9) NATURAL GAS TO UNIVERSAL LP GAS CONVERSION PROCEDURE

Appliance models: Gas stainless steel cooktop models:

BSGH30-ANZ	1 Burners
BSGH32-ANZ	2 Burners
BSGH64-ANZ	4 Burners
BSGH75-ANZ	5 Burners
BSGH95-ANZ	5 Burners

1. Remove each burner cap and burner skirt.
2. Remove the Natural Gas main injector with a 7 mm/VF tube spanner and replace with the appropriate size Universal LP Gas main injector for each burner. The following injector sizes are required for Universal LP Gas:

Burner	Main injector
Wok	1.00 B mm
Rapid	0.91 mm
Semi Rapid Reduced	0.60 mm
Semi Rapid	0.70 mm
Auxiliary	0.53 mm

3. Remove the control knob, with a thin shaft blade screwdriver down the centre of each gas valve shaft, screw the by-pass injector fully clockwise.
4. Shut off gas supply to the appliance.
5. Disconnect gas inlet pipe from the Natural Gas Regulator.
6. Remove the Natural Gas Regulator from the appliance.
7. Fit the Universal LP Gas test point inlet fitting supplied in the conversion kit.
8. Connect the gas supply to the inlet fitting.
9. Check for gas leaks. Do not use a naked flame to check for gas leaks.
10. Adjust the gas pressure to 2.75 kPa.
11. Test the appliance on both high and low flame for each burner and check the gas pressure. If the burner fails to remain alight or the flame is not stable on the simmer setting, adjust the by-pass screw, until flame is stable.
12. If not already removed, remove the "Only for use with Natural Gas" label adhered to the bottom panel near the gas connection.
13. Fit the new data label included in the gas conversion kit.

CONVERSIONS

10) REPLACING THE INJECTORS

The burners can be adapted to different types of gas by installing injectors suited to the type of gas required. To do this, first remove the burner tops using a wrench "B". Now unscrew injector "A" (see fig. 10) and fit a injector corresponding to the type of gas required.

It is advisable to tighten the injector in place.

After the injectors have been replaced, the burners must be regulated as explained in paragraphs 7. The technician must reset any seals on the regulating or pre-regulating devices

and affix the label corresponding to the new gas regulation on the appliance instead of the already existing one. This label is supplied in the packet containing the spare injectors.

The envelope with the injectors and the labels can be included in the kit, or at disposal to the authorised Customer Care Department.

For the sake of convenience, the nominal rate chart also lists the heat inputs of the burners, the diameter of the injectors and the working pressures of the various types of gas.

BURNER ARRANGEMENT ON THE COOKTOP

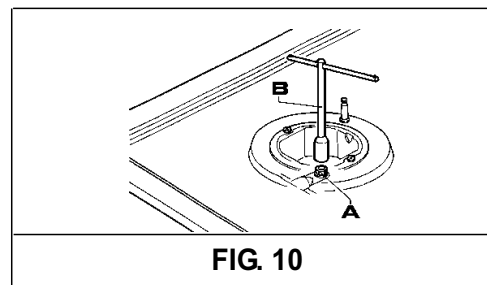
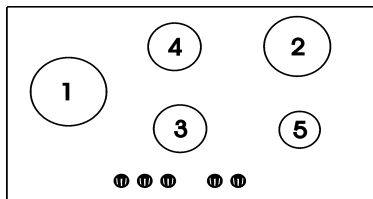
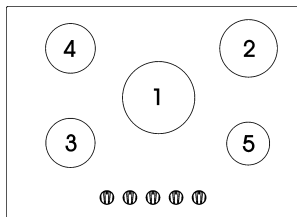
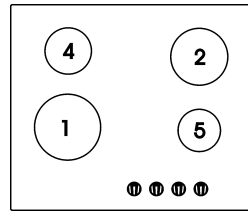
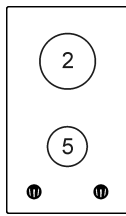
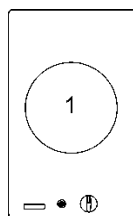

TABLE 1

BURNERS		GAS	NORMAL PRESSURE (kPa)	INJECTOR DIAMETER (1/100 mm)	NOMINAL HEAT INPUT (MJ/h) MAX.	BY PASS
N°	DESCRIPTION					1/100 mm
1	ULTRA RAPID	U-LPG NATURAL	2.75 1.00	100 B 1.75 B	12.6 14.5	85 1/2
2	RAPID	U-LPG NATURAL	2.75 1.00	91 155	10.4 12.0	45 5/8
3	SEMIRAPID REDUCED	U-LPG NATURAL	2.75 1.00	60 105	4.9 5.4	35 1/2
4	SEMIRAPID	U-LPG NATURAL	2.75 1.00	70 120	6.3 7.1	35 1/2
5	AUXILIARY	U-LPG NATURAL	2.75 1.00	53 90	3.6 4.1	32 3/8

SERVICING

CABLE TYPES AND SECTIONS

TYPE OF COOKTOP	TYPE OF CABLE	SINGLE - PHASE POWER SUPPLY
Gas cooktop	H05 RR - F	Section 3 x 0.75 mm ²

ATTENTION!!!

If the power supply cable is replaced, the installer should leave the ground wire longer than the phase conductors (fig. 11) and comply with the recommendations given in paragraph 6.

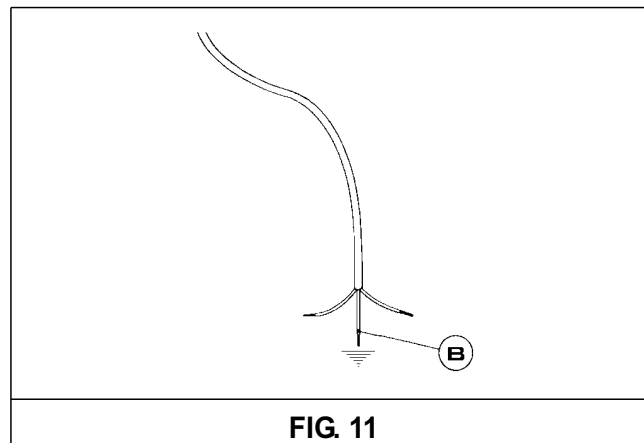

TECHNICAL ASSISTANCE AND SPARE PARTS

Before leaving the factory, this appliance will have been tested and regulated by expert and specialised personnel in order to guarantee the best performances.

Any repairs or adjustments which may be subsequently required may only be carried out by qualified personnel with the utmost care and attention.

For this reason, always contact your Dealer or our nearest After Sales Service Centre whenever repairs or adjustments are required, specifying the type of fault and the model of the appliance in your possession.

Please also note that genuine spare parts are only available from our After Sales Service Centres and a qualified retail outlets.

The above data are printed on the data label put on the inferior part of the appliance and on the packing label.

The above informations give to the technical assistant the possibility to get fit spare parts and a heaven-sent intervention. We suggest to fill the table below.

MARK:

MODEL:

SERIES:

Think Appliances Pty Ltd.
416-424 Barry Rd
Coolaroo VIC 3048

Sales Telephone

1300 132 824

Service Telephone

1800 444 357

Website

www.thinkappliances.com

Applico Ltd.
Private Bag
92900
Onehunga, Auckland,
New Zealand 1061

Website

www.applico.nz

United Kingdom
Baumatic Ltd.,
Baumatic Buildings,
6 Bennet Road,
Reading, Berkshire
RG2 0QX
United Kingdom

Sales Telephone

(0118) 933 6900

Website:

www.baumatic.co.uk